



DEXON CANADA AIR SYSTEMS INC.

BLOWER HEATER OWNERS MANUAL

OWRVDH SERIES



PROVIDING SAFETY VENTILATION TO THE WATER, WASTER WATER INDUSTRY

SINCE 1986

CONTENT

- 1. GENERAL COMMENTS2
 - 1.1. INTRODUCTION2
 - 1.2. PURPOSE2
- 2. OPERATOR AND EQUIPEMENT SAFETY3
 - 2.1. OPERATOR SAFETY3
 - 2.2. EQUIPMENT SAFETY3
- 3. CONTROL PRINCIPALS4
 - 3.1. SEQUENCE OF OPERATIONS4
 - 3.2. FEATURES5
 - 3.3. OPTIONS5,6
 - 3.4. STATUS INDICATION6,7
- 4. INSTALLATIONS8
 - 4.1. INSTALLATION REQUIREMENTS8
 - 4.2. INSTALLATION INSTRUCTIONS8,9,10
 - 4.3. PERFORMANCE CHECK10,11,12
- 5. MAINTENANCE13
 - 5.1. MAINTENANCE INSTRUCTIONS13,14
- 6. TROUBLE SHOOTING GUIDES15
 - 6.1. TROUBLE SHOOTING GUIDE15
 - 6.2. MAIN CONTROL BOARD - RVDH16,17,18
 - 6.3. STATUS BOARD – RVDHSTS.18,19, 20,21
- 7. WARRANTY.....22
- 8. DRAWINGS.....23
 - 8.1. DIMENSIONS.....24
 - 8.2. BOTTOM FOOTPRINT.....25
 - 8.3. INTERNAL WIRING.....26
 - 8.4. FIELD WIRING.....27
 - 8.5. OPTIONAL 95ALM ALARM MODULE (IF APPLICABLE).....28
- 9. APPENDICES:
 - 10. Spare Parts List, Specs Sheet, Fan Curve, Control Section Removal, Quality Control Test Report

1. GENERAL COMMENTS

1.1 INTRODUCTION

Dexon blower heaters are CSA Certified and designed to meet the requirements of the Canadian Electrical Code. The OWRVDH series is suitable for outdoor wall mounted applications where filtration of intake air is desired.

FEATURES

- Overheat Protection
- Low Temperature Shut Down
- Discharge Temperature Sensor
- Adjustable Fan Speed in Auto Mode
- Full Fan Speed in Manual Mode
- Auto Reset
- Fan Boost Start
- Air Proving
- Air Intake Filter Track
- Regulated Air Velocity
- Staged Heating for Larger Units
- CSA Certified

OPTIONS

- Various Installation Configurations; outdoor wall mounted – OWRVDH series, indoor inline or wall mounted without louvers – IRVDH series, indoor wall mounted with louvers - WRVDH series and outdoor freestanding – SRVDH series
- Voltages from 120-600VAC, 1 or 3 phase
- Class 1 Div. 2, Gas Groups C & D, Temp. Code T2C and Ordinary Location Certified
- External Alarm Interfacing
- Manual Mode interface for Hatch/Lid Switch or PLC etc.

1.2 PURPOSE

To provide continuous positive pressure safety ventilation to pumping station wet wells, dry wells, buildings, vaults and chambers for the safety of the operator and to provide a less corrosive environment for equipment.

The OWRVDH series is equipped with filtration and provides a continuous preset airflow by automatically increasing fan speed to compensate for obstructions to the airflow.

A function of the blower heater is to temper the ventilating air in order to mitigate the risk of freezing the ventilated space. They will maintain a preset discharge temperature of between +6°C to +18°C with an adjustable 5° range. If the discharge temperature drops below 0°C (typically) the blower heater will shut down to prevent the ventilated space from freezing.

This equipment is suitable for use in Class 1, Division 2, Groups C and D, Temp. Code T2C or for Non-Hazardous Locations only.

2. OPERATOR AND EQUIPMENT SAFETY

2.1 OPERATOR SAFETY

The installation, operation and maintenance of this unit must be carried out by qualified personnel only and in accordance with national and local electrical codes.

For your safety read the supplied Owner's Manual and Installation Instructions before installing.

Ensure all required lock-out procedures are followed.

Take note of all the safety labels on the unit.

If entering a confined space always follow confined space entry procedures.

Switch the blower heater into "Manual" mode to purge the space before entering. NEVER leave the unit in "Manual" mode unattended.

2.2 EQUIPMENT SAFETY

Store the blower heater in a safe dry environment prior to installation.

Ensure that the factory preset continuous airflow meets the onsite requirements.

We strongly recommend providing surge protection.

When installing/servicing ensure all latches are used to secure the door.

We do not recommend installing on a down pipe smaller than the discharge outlet.

Ensure there is adequate distance between intake louvers and pressure relief vent/gooseneck.

Follow regular maintenance procedures as outlined in section 5.1 of this manual.

Locations with higher debris accumulation such as vegetation, construction, road dust or salt may require more monitoring and maintenance.

Do not leave the blower heater in "Manual" mode unattended.

IMPORTANT: The blower heater must run continuous. NOT all components in the unit are corrosive resistant and rely on the continuous positive pressure of the unit to keep the damaging moist and corrosive gases from entering the blower heater. If the blower heater cannot be immediately started or run continuously, on site actions must be taken to prevent corrosive gases and moisture from entering the blower heater.

WARNING: EXPLOSION HAZARD; SUBSTITUTION OF COMPONENTS MAY IMPAIR SUITABILITY FOR CLASS 1, DIV. 2.

3. CONTROL PRINCIPALS

3.1 SEQUENCE OF OPERATION

- The main PCB inside the unit controls the blower heater functions, the fan and powers the status board.
- A temperature sensor at the discharge of the unit regulates the heating elements to maintain a preset temperature that is based on airflow requirements and location.
- In this series the heating elements are staged to reduce power consumption. Stages 2 and 3 will only be activated and will only remain on when stage 1 cannot meet the demand. Stage 2 and 3 LEDs will not blink but remain constant.
- In “Auto” mode the fan will run continuous at an adjustable preset speed based on airflow requirements and heating capacity of the unit; the fan speed will automatically increase in order maintain the airflow requirement. In “Manual” mode the fan will run at full speed.
- The status board provides an indication of the original preset “Set Level” blower speed versus the real time condition “Running Level” based on requirements. When “Running Level” reaches its maximum the “Max Speed” indication on the status board will indicate that loss of air is imminent and further loss of air will result in a “No Air” condition.
- When the discharge temperature drops below 0°C (typically) the unit will go into a “Low Temp.” shut down condition, shutting down the fan to prevent freezing of the ventilated space.
- The unit will automatically restart when the discharge temperature reaches +2°C (typically) or more.
- A built-in timer overrides this shut down for 7-8 minutes when the unit is manually reset or power is cycled to allow the elements to warm up the discharge temperature. This override does not apply when the unit automatically restarts after a “Low Temp.” shut down.
- If the discharge temperature rises above the normal operating range the unit will go into an “Overheat” condition cutting power to the heating elements. After cooling down, the heating elements will automatically restart.
- Power to the heating elements will also be cut in the event of a fan failure or a “Low Temp.” shut down condition that caused the fan to shut down.
- A fan failure will indicate a “No Air” status on the status board. If the optional alarm module is used it will initiate a remote alarm even if there is no power to the status board.

CAUTION: Leaving the blower heater in “Manual” mode will drive the fan at full speed and will override the “Low Temp.” shut down feature. The unit should never be left in “Manual” mode since the heating capacity of the unit is based on preset airflow rate and continuous duty in “AUTO” mode.

3.2 FEATURES:

- **Overheat protection:** For Ordinary Location rated units one Klixon thermostat located at the top of the element mounting panel will shut down the heating elements if temperature at the top of the heat exchanger rises above approx. 65°C. For Hazardous Location rated units additional thermostats on each element will cut power when the skin temperature of the elements reaches approx. 107°C.
- **Low Temperature Shut Down:** When the sensor at the discharge of the blower heater senses temperature lower than 0°C (typically) the unit will go into a “Low Temp.” shut down condition to prevent freezing of the ventilated space. See sequence of operations for more information.
- **Discharge Temperature Sensor:** Monitors the discharge temperature to regulate the heating elements to maintain a preset discharge temperature of between +6°C to +18°C with an adjustable 5° range (Example: A +6°C preset discharge temperature would be adjustable from +5°C to +10°C and +15°C preset temp. would be adjustable from +13°C to +18°C).
- **Auto Reset:** The blower heater will automatically reset when temperatures reach +2°C (typically) after a “Low Temp.” shut down has occurred and after the elements have sufficiently cooled from an “Overheat” condition.
- **Regulated Velocity:** An airflow sensor at the discharge measures the air velocity and interfaces with the main controller to adjust the fan voltage as required, to maintain the adjustable preset velocity. The status board provides indication of the “Set Level” (preset velocity) versus the real time “Running Level”.
- **No Air Indication:** A “No Air” condition will be indicated when the “Running Level” reaches its maximum and there is further airflow, when the fan fails or when a “Low Temp.” shut down condition has occurred.
- **Fan Boost Start:** Provides a momentary full output voltage to the fan for cold start-up.
- **Staged Heating:** Staged heating is only provided for the larger OWRVDH/IRVDH/WRVDH/OWRVDH series blower heaters to prevent high current draw and reduce power consumption when not required. Stage 2 and Stage 3 heating elements will only be used if Stage 1 is not able to maintain the preset discharge temperature setting and only as required to maintain this discharge temperature.
- **CSA Certified:** Dexon blower heaters are CSA certified for Class 1, Div. 2, Gas Groups C & D, Temp. Code T2C Locations and for Ordinary Locations. Any modifications to existing certified units will require special CSA approvals/certification.

3.3 OPTIONS:

- **Various Installation Configurations:** The OWRVDH series blower heaters are for outdoor, through the wall applications with either back or bottom air outlets (See IRVDH and WRVDH series for indoor inline or indoor wall mounted and SRVDH series for outdoor freestanding).
- **Discharge Outlet:** Can be rectangular or round; size dependent on capacity.
- **Filtration Options:** Hog Hair, Polyester Blend media or both.
- **Available Voltages:** All Dexon blower heaters require two circuits; one for controls and one for heating elements. Controls require 120VAC and heating elements can be 120,208,240,480 or 600 Volt and can be 1 phase or 3 phase.

- **External Alarm Interfacing:** An optional “RDHALM” three alarm status output relay module is available for interfacing with external alarms or PLC. The alarm module can be easily added after installation if required.
- **Manual Mode Interfacing:** A set of manual mode interfacing terminals is available for dry contact only, input from PLC, Hatch/Lid Switch, Gas Detector etc. dry contacts to temporarily initiate “Manual” mode (full fan speed) for added safety.

WARNING: The remote manual mode interface feature is intended to temporarily turn on “Manual” mode (full fan speed) for added safety regardless of the position of the “Auto/Manual” toggle switch on the status board. If the unit was previously in “Auto” mode it will return to “Auto” mode when the remote dry contact opens. If it was in “Manual” mode the blower heater will remain in “Manual” and should be switched back to “Auto”. The unit should never be left in “Manual” mode since the heating capacity of the unit is based on preset airflow rate and continuous duty in “AUTO” mode.

3.4 STATUS INDICATION

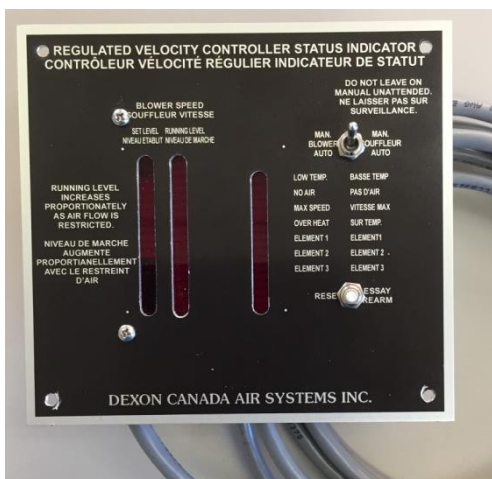

Status Board - RVDHSTS

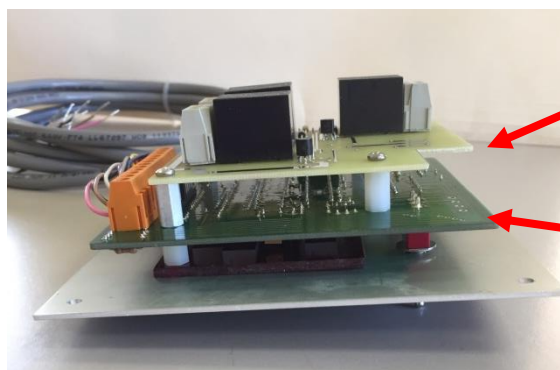

Status Board with Optional Alarm Module RDHALM

The blower heater is equipped with a status board to provide the following status indications:

- Blower Speed Set Level – indicates the preset fan speed via a user set jumper on the back of the status board, pegged to match running level at install with clean filters.
- Blower Speed Running Level – indicates the fans actual real time running speed required to compensate for air flow obstructions.
- Low Temp. – indicates the unit has gone into a “Low Temp.” shut down condition.
- No Air – indicates a fan failure, significant loss of air or “Low Temp.” shut down.
- Max. Speed – indicates the fan has reached its maximum speed and any further loss of air will signal a “No Air” alarm.
- Overheat – indicates the unit has gone into an “Overheat” condition.

- Element 1 – indicates there is a heat demand and the LED can be blinking or constant.
- Element 2 & 3 – indicate stage 2 or 3 are required to maintain the desired temperature. These LEDs will not blink they will remain constant.

The status board also has two switches:

1. “Man. Fan Auto” to switch the unit from “Auto” mode to “Manual” mode.
2. “Reset” switch that will restart the unit after a “Low Temp.” shut down has occurred.

Optional features that can be added to the status board:

1. An optional Alarm Module is available to interface with external alarms or PLC to provide three status output alarms; “No Air”, “Low Temp.” and “Overheat”. **Optional Alarm module sold separately.**
2. A Manual Mode interface terminal is available for input from PLC, Lid Switch etc. dry contact, to initiate “Manual” mode (full fan speed).

Standard cable length – 3 meters with the status board and 8 meters with the blower heater unless otherwise requested.

Please see status board Trouble Shooting Guide for more information.

Status Board Dimensions:

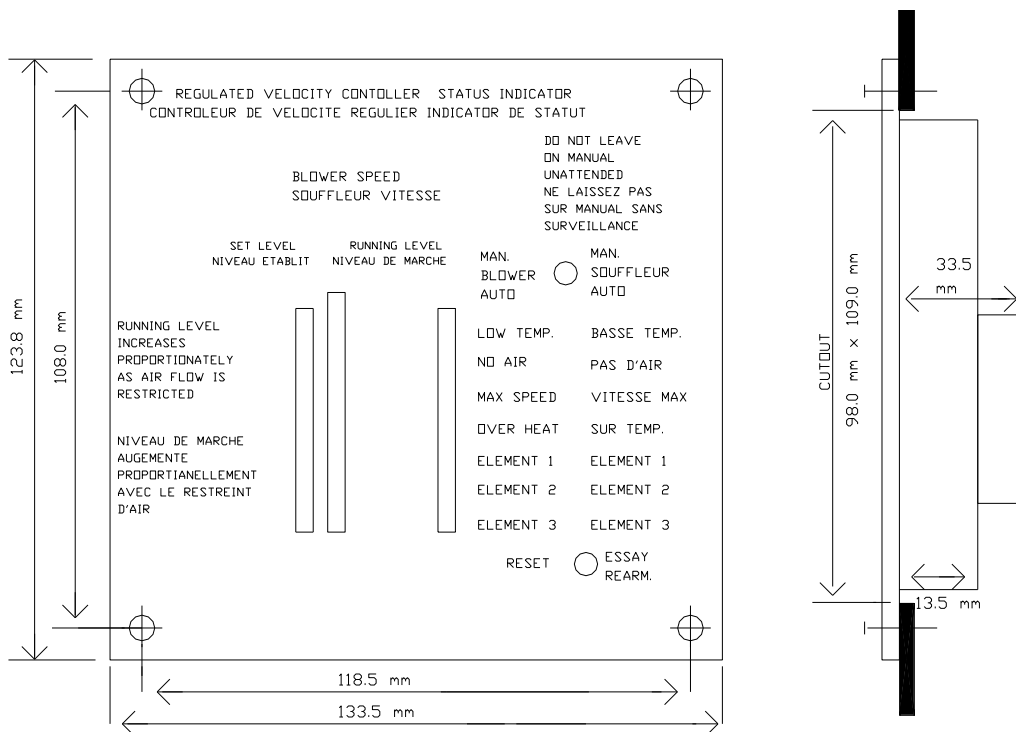

The status board is not weather resistant and must be installed in an appropriate enclosure, remote from hazardous locations in accordance with local electrical codes.

4. INSTALLATION

4.1 INSTALLATION REQUIREMENTS

- Status board must be installed in a suitable enclosure remote from hazardous locations in accordance with local electrical codes.
- Class 1, Div. 2 units must be fused remote from hazardous locations.
- We recommend a pressure relief vent/gooseneck is at least equal in cross section to the discharge outlet.
- Ensure the pressure relief vent/gooseneck is not in close proximity to the blower heater louvers.
- Maintain 305 mm (12") clearance to the bottom of the intake louvers for accumulating debris or drifting snow.
- Maintain a minimum of 1 meter (3'3") clearance on control access side of the blower heater for maintenance and servicing.

IMPORTANT: The blower heater must run continuously. NOT all components in the unit are corrosive resistant and rely on the continuous positive pressure of the unit to keep the damaging moist and corrosive gases from entering the blower heater. If the blower heater cannot be immediately started or run continuously, on site actions must be taken to prevent corrosive gases and moisture from entering the blower heater.

4.2 INSTALLATION INSTRUCTIONS

All installations must be done by qualified personnel and in accordance with local electrical codes.

1. Using the 4 stainless steel bolts mount the blower heater to a raised flanged down pipe or directly over a hole at the top of the ventilated space. See the blower heater bottom footprint drawing in appendices.
2. If not pre-mounted, install the status board in a suitable enclosure in a non-hazardous dry location.
3. Run separate conduits; one for the status board cable and one for the appropriate heating and control power circuits.

CAUTION: Do NOT install status board cable in the conduit intended for heating element and power circuits. Doing so will put the extra low voltage circuits in close proximity to low voltage circuits which may cause signal interference.

4. Connect the status board cable at TB3 inside blower heater as per field wiring diagrams in appendices.
5. Supply appropriate heating element and control power circuits to TB7 and TB8 as shown in the field wiring diagram. Note: status and power entry is generally at the base of the unit but may also be on the side with the use of liquid tight fittings.
6. Power up the heating element circuit at TB8 first so the elements have power available if there is a heat demand.
7. Power up the control circuit. The “Blower Speed – Running Level” bar graph should light up and the blower will receive a boost start voltage to allow the fan to start in cold climates (this occurs every time the unit is powered up). The “Blower Speed” will then drop to the preset idle speed and in approx. 1-2 minutes will adjust to meet the preset “Set Level” as set by Dexon. The “Running Level” bar graph should settle to match the “Set Level”. At this point if they do not line up the installer must re-peg the running level to match the set level in order to mark the starting point for the blower speed with clean filters. The “Running Level” will then increase as the filter saturates. This is done on the back of the status board by moving a jumper to match the “Running Level” (see figure below). Please note if the optional alarm module is used it will have to be removed to access the jumper bar.

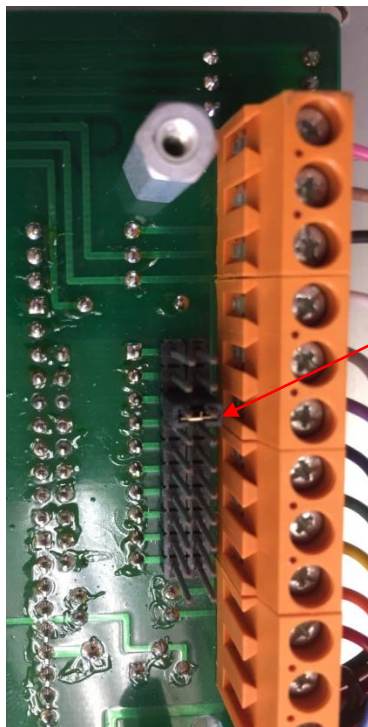

Jumper bar for pegging the Running Level to match the Set Level

Optional Alarm Module

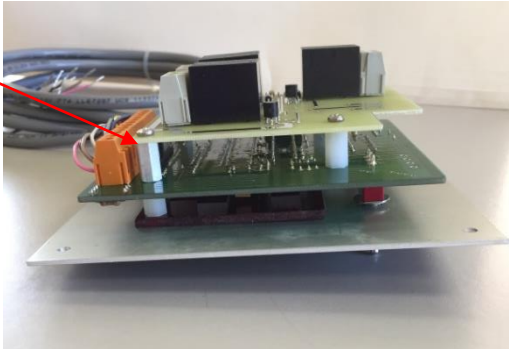

If the Optional Alarm Module is used it will need to be removed to access the Jumper bar.

Note: Upon power up; if the temperature of the air leaving the unit is below 0° C (typically) the “Low Temp.” LED on the status board will light up and a yellow LED on the RVDH main controller will also flash to indicate that a delay timer (which overrides the “Low Temp.” shut down feature) has been activated. This LED will continue to flash for the duration of the timed delay, approx. 7-8 minutes. This override occurs whenever the control power is cycled or the “Reset” switch is pressed (See Trouble Shooting Guide 6.1 for more information).

8. If onsite adjustments to the airflow are required this can be accomplished by adjusting the potentiometer (pot painted red on the RVDH Main Controller). Turning the potentiometer very slowly clockwise will increase the blower speed and counter clockwise will decrease the blower speed. When the new running speed has been established you will need to re-peg the “Set Level” as described above. This must be done with clean filters installed.
9. If there is a heat demand the “Element 1” LED on the status board should light up and should only remain constant momentarily, then blink as it meets the demand. Stage 2 and Stage 3 heating elements will only be used if Stage 1 is not able to maintain the preset discharge temperature setting and only as required to maintain this discharge temperature. Stage 2 and 3 heating elements will not blink but remain steady on. If there is no heat demand then only the pegged “Set Level” and “Running Speed” bar graph should be lit.
10. If required perform function test as described below.

4.3 PERFORMANCE CHECK

NOTE: You will require a means of cooling the temperature sensor to check the heating, “Low Temp.” and the “No Air” functions. We would suggest using ice water or a Dexon Temperature Simulator (sold separately).

To create a demand with ice water; remove the temp. sensor from tubing (Fig.1) and place the sensor in the ice water to create a heating demand and then place the sensor directly on ice to lower the temperature to 0°C to create the “Low Temp.” shut down condition.

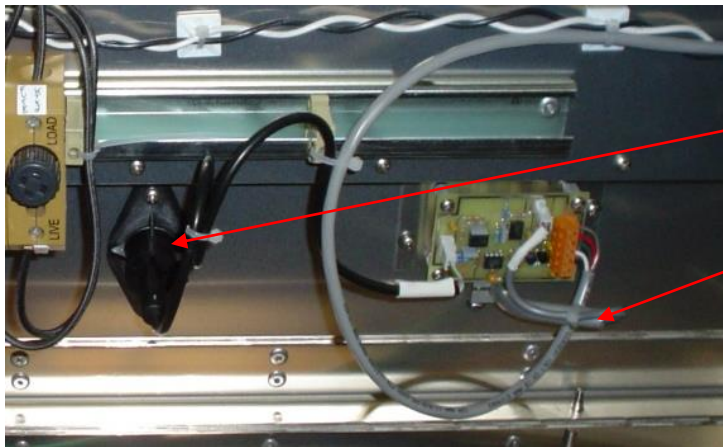

Airflow Sensor

Temperature Sensor Tubing

Fig. 1: Airflow and Temperature Sensors

To create the required demands using the Dexon Temperature Simulator (Fig.2), unplug the temp. sensor from the RVDHAFS Airflow Sensor Board and plug the simulator in its place as shown in Fig.3.



Fig. 2: RVDH Temperature Simulator

Airflow Sensor PCB - RVDHAFS

Temp. Sensor Jack – disconnect temp. sensor and connect the temperature simulator here. Be sure the red and black wires make contact with the pins and the silver wire is left open.

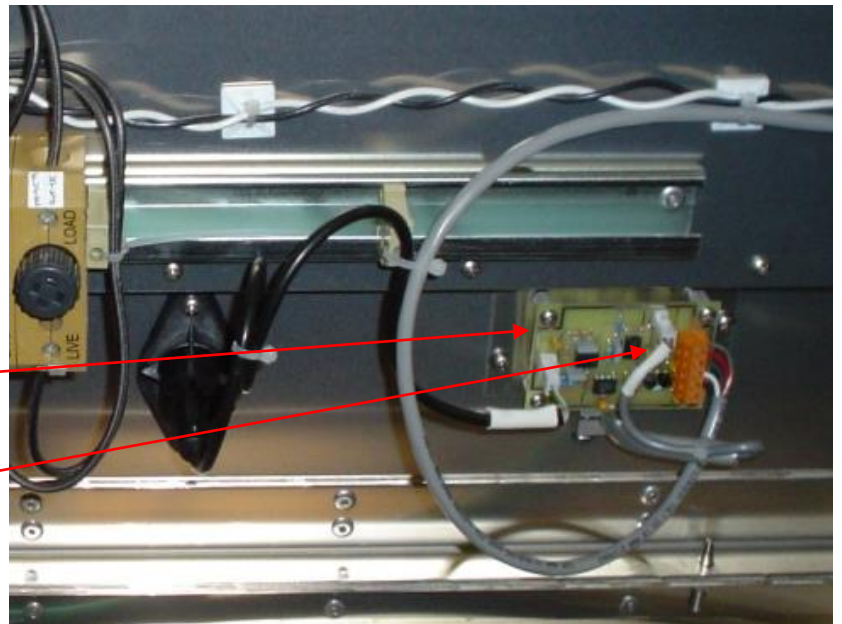

Fig. 3: Airflow Sensor PCB RVDHAFS / Temperature Simulator Connection

1. Start the unit and let it run for APPROX. 8-10 minutes to allow the “Low Temp.” override timer to time out.
2. Create a heating demand by placing the temperature sensor in ice water or using the Dexon Temp. Simulator as described above. Once the heat demand has been created, the “Element” LEDs should light up and there should be current draw at TB8.
3. Create a low temperature condition as described above with ice water or with the Dexon Temp. Simulator to drop the discharge temperature to 0°C. The “Low Temp.” LED should light up and the fan should shut down followed by a “No Air” indication.
4. After the unit has shut down turn the fan switch on the status board to “Manual” (this overrides the “Low Temp.” shut down feature). The fan will come on at full speed and the “No Air” LED will then go off, the “Max Speed” LED should come on and the “Element” LEDs should come on.
5. While still in a “Low Temp.” condition the air proving feature should be tested. This can be done by disconnecting one of the leads from the fan terminal block at TB4 to create a loss of air condition. The “Running Level” bar graph should have ramped up to the top; the “Max Speed” LED should come on and soon after the “No Air” LED should also come on. At this time there should no longer be current drawn on the heating elements at TB8. This confirms the air proving is operating as intended. Remove the loss of air condition that was created.
6. With the unit still in a low temperature condition move the fan switch back to “Auto”. This will cause the fan and heating elements to shut down again and the “Low Temp.” LED and “No Air” LED to light up again.
7. With the unit back in “Auto” mode and still in a “Low Temp.” condition press the “Reset” switch to initiate the 7-8 minute override timer. This will allow the fan and heating elements to operate regardless of the “Low Temp.” condition and the “Low Temp.” LED should go out when the discharge temperature is above 2°C (typically).
8. After the override has timed out remove the created heat demand. If using ice water; replace the sensor in the tubing being sure to insert it all the way to the stopper and if using the Temp. Simulator, unplug from the jack and reconnect the temp sensor. This confirms that the heating demand, “No Air”, “Low Temp.” shut down, “Manual” mode, “Reset” features and indications are functioning as intended.
9. Replace the cable ties and duct seal on the sensor tubing and other conduits as required; check all components and ensure they are secured. Secure the door using all the latches.

10. If desired, a DC voltage representation of the discharge temperature can be monitored during these procedures at test pin “DP” (discharge temperature test pin) as described in section 6.1 Main Controller – RVDH.

5. MAINTENANCE

MAINTENANCE SHOULD ONLY BE PERFORMED BY QUALIFIED PERSONNEL

ONCE A YEAR, PREFERABLY BEFORE THE COLD WEATHER SETS IN, PERFORM THE FOLLOWING MAINTENANCE PROCEDURES:

1. Check the status board for the following indications;
 - a. Both the “Running Level” and “Set Level” bar graphs should be on, but not necessarily in line. The “Running Level” may have gone up if the filters are accumulating debris.
 - b. The fan switch should be in “Auto” mode.
 - c. The “Element 1” LED may be off, steady on or blinking. An off LED would indicate there is no heat demand; a steady on LED would indicate there is a heat demand requiring full element capacity; a blinking LED would indicate the heat demand is being met by intermittent pulses of energy. Stage 2 and 3 may or may not be called for.
2. If the “Blower Speed” bar graphs and “Element” LEDs are the only ones on and if the fan switch is in “Auto” mode and you’ve confirmed that it is actually running, then the unit should be functioning as intended. You may now proceed with the following steps;
 - a. Power down the heating element and control circuits and lock out power as required.
 - b. Remove and replace filters.
 - c. Open the latched door to expose the controls.
 - d. Clear air intake louvers of any debris.
 - e. Clear pressure relief vent/gooseneck of any debris.
 - f. Check all connections to the control section for loose or damaged wires and ensure they are secure.
 - g. Check for any signs of moisture or corrosion in the control section and on the RVDH Main Control Board.

3. Disconnect wires to heating element and controls circuit at TB7 and TB8 and cap-off.
Disconnect the status board wires at TB3 on the main controller and cut any cable ties. Remove screws at the top of the control panel and gently pull the top of control panel towards you and up off the mounting pins (See appendices for how to remove fan/control sections). This allows the complete control section to be removed including the fan, heating elements, thermostats and sensors, then;
 - a. Remove any accumulated debris from the fan blades, heating elements, thermostats and sensors.
 - b. Check the fan, heating elements, thermostats and sensor connections for signs of moisture or corrosion and ensure they are secure.
 - c. Ensure the temperature sensor is inserted all the way to the bottom of the tubing.
4. Replace any damaged or corroded parts. When complete reinstall the control section and reconnect all wiring.
5. Power up the unit and complete the performance check as described under section 4.3.
6. Ensure all conduit holes are completely sealed with duct seal and secure door with using all the latches.

WARNING: Never leave the blower heater in “Manual” mode unattended. Leaving it in “Manual” mode will drive the fan at full speed and will override the “Low Temp.” shut down feature. The unit should never be left in “Manual” mode since the heating capacity of the unit is based on preset airflow rate and continuous duty in “AUTO” mode.

WARNING: EXPLOSION HAZARD; SUBSTITUTION OF COMPONENTS MAY IMPAIR SUITABILITY FOR CLASS 1, DIV. 2.

Please note that if the blower heater is installed in a high debris location, in forests or parks the blower heater may require more frequent cleaning and maintenance.

CONTACT INFORMATION:

Email: techsupport@dexoncanada.com, Website: www.dexoncanada.com
Tech Support Phone: 403-930-1284, Admin Phone: 403-272-0562

6. TROUBLE SHOOTING GUIDES

6.1 STATUS INDICATION TROUBLE SHOOTING GUIDE

<p>There is no lit LED on the status board</p>	<ol style="list-style-type: none"> 1. Check control power to TB7 in blower heater. 2. Check control power fuse and for short circuits. 3. Check fuse on RVDH Main Controller. 4. Check RVDH Main Control Board for damage or for short circuit. 5. Check that the transformer on main controller hasn't come lose or is damaged. 6. Check for 12VDC between brown and grey wires to the status board at TB3 on RVDH Main Controller and the same wires on the status board. 	<ol style="list-style-type: none"> 1. Restore power. 2. Replace fuse if required. 3. Replace fuse if required. 4. Replace or have RVDH Main Controller repaired. 5. Send RVDH Main Controller in for repairs if required. 6. If 12VDC is not present check connections, for short circuit or controller damage and send in for repair if required.
<p>"No Air" LED is on</p>	<ol style="list-style-type: none"> 1. Check the "Low Temp." LED for indication of a "Low Temp." shut down condition. 2. Check fan; if it's not running check fan terminals for corrosion, frost build up or impeller restrictions. 3. Check for fan power at TB5 on RVDH Main Controller. If no power; check connections, check for short circuit or controller damage. 	<ol style="list-style-type: none"> 1. If shut down press the "Reset" switch. 2. Remove restrictions and replace fan if required. 3. If damaged replace or send RVDH Main Controller in for repairs.
<p>"Low Temp." LED is on</p>	<ol style="list-style-type: none"> 1. Check for element power at TB8 in blower heater. 2. Visually inspect all Klaxon thermostat(s) on the elements and on the Heat Sink above the elements for damage or corrosion. 3. Ensure the unit is not in "Manual" mode. 4. Check that the fan voltage is set as per specifications (see quality control test report). 5. Check if the "Overheat" LED is on. 	<ol style="list-style-type: none"> 1. Restore power. 2. Replace damaged Klaxon thermostat(s) if required. 3. Set to "Auto" and press "Reset" switch. 4. Adjust as required. 5. If on see "Overheat" LED below.
<p>"Overheat" LED is on</p>	<ol style="list-style-type: none"> 1. Check overheat thermostat for continuity between the leads at TB4 on main board. It should be in a closed circuit condition. 2. Check element relay(s) for current leakage by disconnecting control power to eliminate any demand and check for a current draw on the element power supply leads. 	<ol style="list-style-type: none"> 1. If in open circuit condition check the thermostat for damaged leads and replace as required. 2. If there is current draw and there is no demand replace the relay(s).
<p>"Element" LED is off or inactive</p>	<ol style="list-style-type: none"> 1. Check if the ambient outdoor temperature is not above the discharge set point as indicated on the quality control test report in appendices. 2. If the ambient temp. is below the set point check if unit is in "Low Temp." shut down condition or in "Overheat" due to corroded overheat thermostat. 3. Check that there is power to the status board and TB7 on the main controller. 	<ol style="list-style-type: none"> 1. If the ambient temperature is above the set point then there is no demand; unit is working as intended. 2. Refer to "Low Temp." shut down and "Overheat" conditions above. 3. Refer to status board "Power On" condition above.

If the above recommendations do not solve the problem please contact Dexon Canada Air Systems at 403-930-1284 or email techsupport@dexoncanada.com.

6.2 MAIN RVDH CONTROL BOARD

“Low Temp.” shut down bypass timer LED: The LED will blink until the timed delay has ended. Note: In order to allow time for the heat sensor to reach its set point temperature a 7-8 minute bypass is built into the controller for cold starts. If the discharge temperature is below 0°C and the set point is not reached in the allotted time the blower heater will go into a “Low Temp.” shut down condition.

To normally closed
overheat thermostat
in heat exchanger

12VDC output to
Crydom SS Heating
Relays. May be
Pulsing or Steady
stg3 stg2 stg1 12VDC

Heat 3
Heat 2
Heat 1
Overheat
Common
Low Temp.
No Air
Fan Manual Mode
Manual Reset
Fan SC Display
+5Volt Power
+12V Power
TO STATUS BOARD

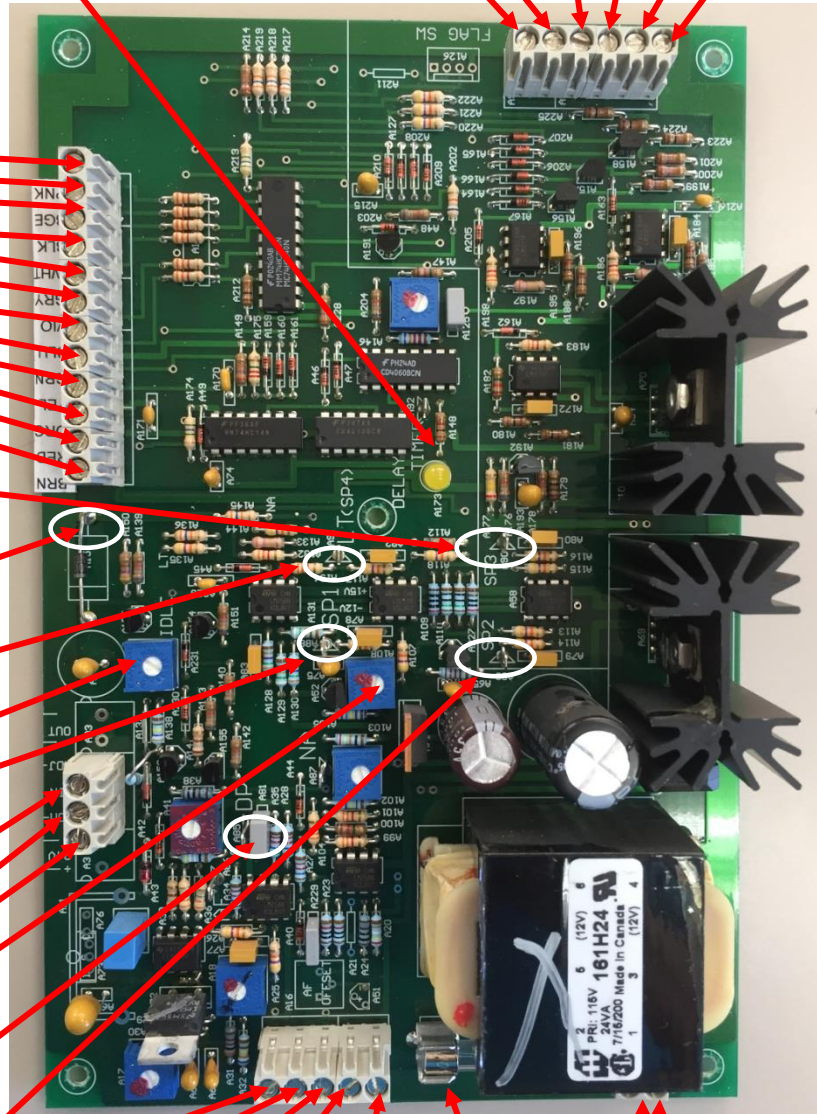

“SP3” – Stage 3 Temp. Set Point Test Pin.
Positive Lead on DC Volt Meter 0-20V Range

“COM” Common Test point. Negative Lead on
DC Volt Meter 0-20V Range

“SP4” – Low Temp Restart Test Pin. Positive
Lead on DC Volt Meter 0-20V Range

Fan Idle Adjustment Potentiometer

“SP1” – Stage 1 Temp. Set Point Test Pin.
Positive Lead on DC Volt Meter 0-20V Range

0 to 10VDC should be present here. 0-10VDC
Fan volts are variable with Fan
Adjustment Pot 24/48VDC
Com

“SP” – Set Point Potentiometer for Discharge
Temperature Adjustments

“DP” – Discharge Temperature Test Pin.
Positive Lead on DC Volt Meter 0-20V Range

“SP2” – Stage 2 Temp. Set Point Test Pin.
Positive Lead on DC Volt Meter 0-20V Range

+5V AT +12V AV Com
Interfacing with Airflow
Sensor Board RVDHAFS

120Volt Power
120VAC should
be present here

Controller Fuse Brackets – 750MA -
Type AGC Fuse

IMPORTANT: Please contact Dexon Canada Air Systems Inc. before adjusting any potentiometers (pots). There are only 2 pots that can be adjusted onsite and this should only be done when absolutely necessary and by qualified personnel only.

DEXON RVDH MAIN CONTROLLER TEST PINS DESCRIPTION

NOTE: We recommend using “Minigrabber” type test leads that clip/hook on to the test pin holes for measurements on the main controller to prevent accidentally shorting out test pins to components in close proximity. IMPORTANT: When taking measurements the voltage does not equate exactly to temperature, there is a 0.1VDC offset; for example (0.7VDC = 6°C), (1.1VDC = 10°C), (0.9VDC = 8°C).

TEST PIN	DESCRIPTION
COM	- Is the common point for all RVDH Main Controller and Airflow Circuit Board voltage tests (0-24VDC Range). The negative from a DC Volt Meter goes here for each sampling.
DP	- Is the Discharge actual temperature as per the temperature sensor located near the bottom of the blower heater in a small aluminum tube (See Dexon RVDH Main Controller for Temperature Sensor Jack).
SP1	- Is the set point temperature that will be maintained at the blower heater discharge at the bottom of the blower heater. The desired temperature may be adjusted by turning “SP” (Set Point discharge temperature adjustment potentiometer) clockwise to increase or counter clockwise to decrease. Typical range is +5°C to +10°C (0.6VDC to 1.1VDC). IMPORTANT: Please contact Dexon Canada Air Systems Inc. (403-272-0562) before making any adjustments to any potentiometers. Note: the airflow in “Auto” mode is preset by Dexon based on airflow requirements and heating capacity. Increasing the airflow should only be done if airflow is inadequate due to unforeseen on-site piping/ducting friction. Adjustments should only be made when absolutely necessary and by qualified personnel.
SP2	- Is the set point at which the stage 2 element will engage in order to maintain SP1 set point. As the outdoor temperature drops the stage 2 elements are called upon to provide heat when the DP (down pipe) temperature sensor drops to where the SP2 set point is set. Typically 0.5VDC = +4°C.
SP3	- Is the set point at which the stage 3 element will engage in order to maintain SP1 set point. As the outdoor temperature drops the stage 3 elements are called upon to provide heat, when the DP (down pipe) temperature sensor drops to where the SP3 set point is set. Typically 0.35VDC = +4.5°C.
SP4	- Is the low temperature automatic restart set point. This is the temperature at which the blower heater will automatically restart after a “Low Temp.” shut down has occurred. A “Low Temp.” shut down occurs when the discharge temperature drops below 0°C (typically) and the fan shuts down to prevent freezing of the ventilated space. As the outdoor temperature warms up the fan will automatically reset and start up based on the SP4 temperature set point. Typically 0.2VDC = +1°C.

CONTACT INFORMATION:
 Email: techsupport@dexoncanada.com, Website: www.dexoncanada.com
 Tech Support Phone: 403-930-1284, Admin Phone: 403-272-0562

6.4 AIRFLOW SENSOR BOARD – RVDHAFS

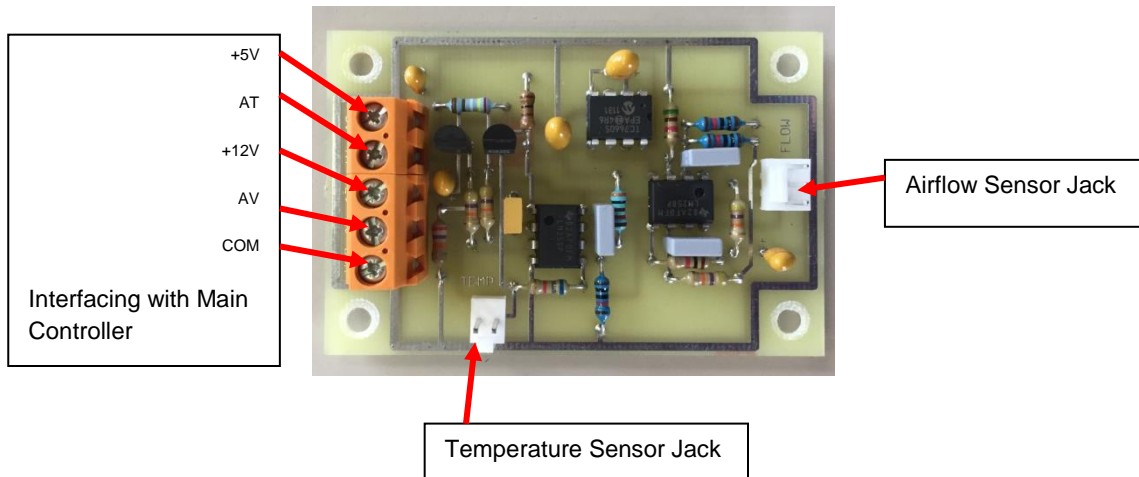

6.4 STATUS BOARD – RVDHSTS

The information provided on these pages assumes there IS a problem and there are no issues with the RVDH Main Controller, the RVDHSTS Status Board or wiring problems.

“Power On” Indication via “Running Speed” bar graphs: When the “Set Level” and “Running Level” are lit the status board is receiving power from the main controller located inside the blower heater. If it is not lit - check to ensure the control power circuit is energized inside the blower heater. If the circuit is energized; check the fuses leading up to and on the main controller, then check the wiring between the blower heater and the status board.

“Element 1” LED: When this LED is blinking/pulsing it’s an indication that the outdoor temperature is such that the main controller is calling for heat. The continuous blinking/pulsing indicates that the blower heater is easily maintaining the pre-set discharge temperature.

Note: “Element 2” and “Element 3” LEDs will only be active when stage 1 cannot maintain the preset discharge temperature on its own and stage 2 and/or stage 3 elements are required. These LEDs will not blink/pulse.

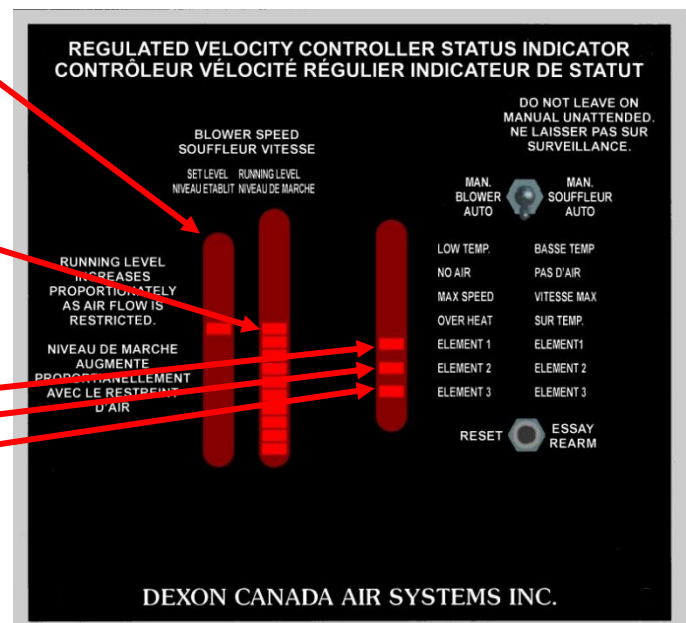

Figure 1: Normal Operation

“Overheat” LED: When lit indicates that an “Overheat” condition has occurred. This condition may be the result of either the Crydom Solid State Relay failing, the overheat thermostat at the top of the heat exchanger has had its wiring corrode off or has opened its internal contact (normally closed contact becomes open).

Relay Fail test: Turn off the control power and check for current in the heating circuit. If a current is measured the relays could be leaking across their voltage barrier, have found a current path to ground or have completely shorted out.

Overheat Sensor test: If the relays are fine check the continuity of the overheat thermostat, it should be in a normally closed state to allow heating. See Dexon RVDH Main Controller page for location of the overheat thermostat wires.

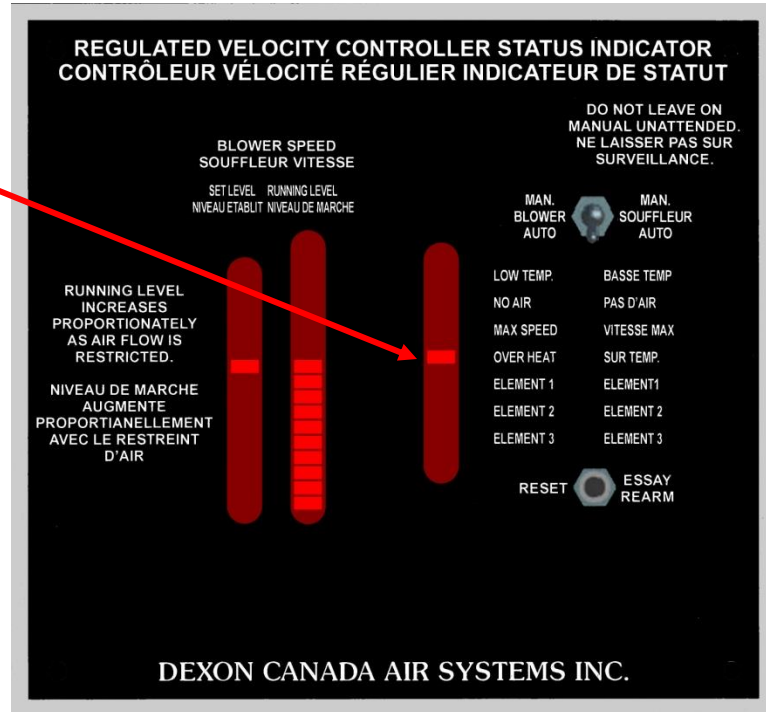

Figure 2: “Overheat” Indication

“Blower Speed” bar graphs, “No Air” & “Max Speed” LEDs: If the “Max Speed” and “No Air” LEDs are both lit and the “Running Level” has reached the top of the bar graph, this could be an indication that either the fan or airflow sensor has failed, the filters are completely saturated or there is an obstruction to the airflow and the safety ventilation is being compromised. If there is confirmation of the fan running there may be issues with the RVDH Main Controller or status board. If fan is not running; confirm that there is power output from the RVDH Main Controller to the fan. If you confirmed the fan is running and there is still a “No Air” indication then there is an issue with one or more of the control boards.

IMPORTANT: When the “No Air” LED is lit the heating elements are disabled for safety. If the outdoor temperature is below 0°C this will lead to a “Low Temp.” shut down condition; if this does occur then the “Low Temp.” LED will also light up.

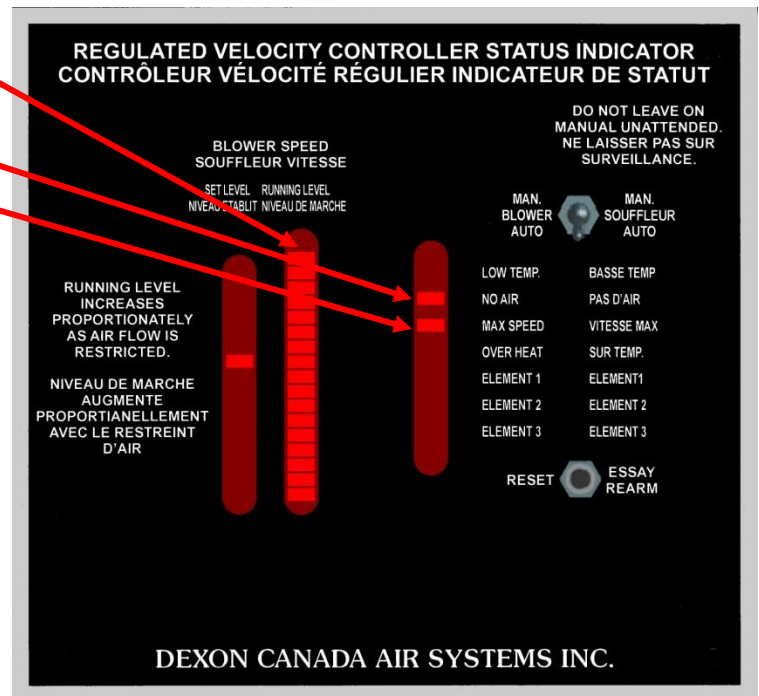

Figure 3: “No Air” Indication

“Blower Speed” bar graphs, “No Air” & “Low Temp.” LEDs: This condition is most common in cold temperatures. This can be due to a “Low Temp.” shut down condition which causes the “No Air” indication or a “No Air” indication which activates the “Low Temp.” shut down feature since the “No Air” condition will disable the heating elements. This occurs at temperatures below 0°C (typically).

The “Low Temp.” LED: Will light up due to a lack of heating; the heating circuit is off or one or more heat sensors are open. If the main overheat sensor is open an “Overheat” LED will also be lit (Fig. 2). This is most commonly due to corroded wire leads in the heat exchanger. It could also be caused by a temperature sensor failure, a sensor out of calibration or the RVDH Main Controller has failed.

Note: A “Low Temp.” condition can also occur in Class 1, Div. 2 blower heaters as they have overheat thermostats mounted directly on each of the heating elements. These normally closed thermostats shut down the heating if the heating element skin temperature reaches close to ignition temperature of the gases in the Gas Groups C & D. There is no status indication for this condition; check for open contact, corroded wires etc.

The “No Air” LED: Will light up in the event of a fan failure or if a “Low Temp.” condition occurred as described above. Check the fan for operation and check to ensure the heating circuit is energized (breaker is on).

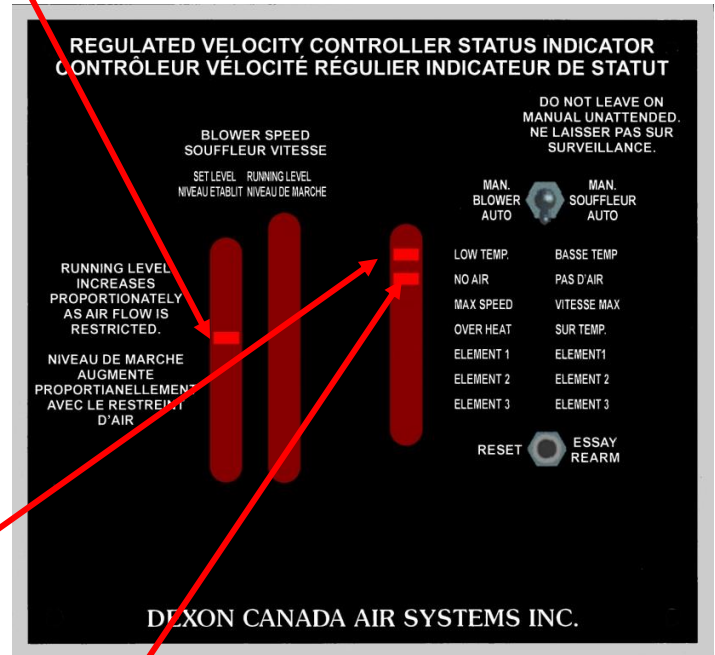

Figure 4: “No Air” Indication with “Low Temp.” Indication

**“Manual/Auto” Toggle Switch:
DO NOT LEAVE UNIT IN MANUAL MODE
UNATTENDED**

This switch is primarily used to purge/flush/ventilate a confined space prior to entry.

In “Auto” mode the blower heater runs at a preset level based on the required airflow rate; generally based on the area of the space and the safety ventilation requirements of the location. For continuous airflow in “Auto” mode all safety features of the unit are active.

In “Manual” mode the fan is put into full speed causing the “Running Level” bar graph to reach the top and the “Max Speed” LED to light up; this is to purge/flush/ventilate the space only. This is not meant for continuous operation since the heating capacity of the unit is sized for only the continuous airflow rate.

It is important to note that in “Manual” mode the “Low Temp. shut down feature is bypassed/disabled to ensure the unit does not shut down while the confined space is occupied. This bypass can be used to allow heating even in a “Low Temp.” shut down in order to defrost the fan if frosted up. The fan will often restart once

“Reset” Switch:

This switch is used in order to start a bypass timer built into the main controller that will allow heating for roughly 7-8 minutes regardless of the “Low Temp.” shut down condition. This is done in an attempt to warm the temperature sensor above freezing and remove the “Low Temp.” shut down condition. This is provided the heating elements have power and the “No Air” LED is not lit.

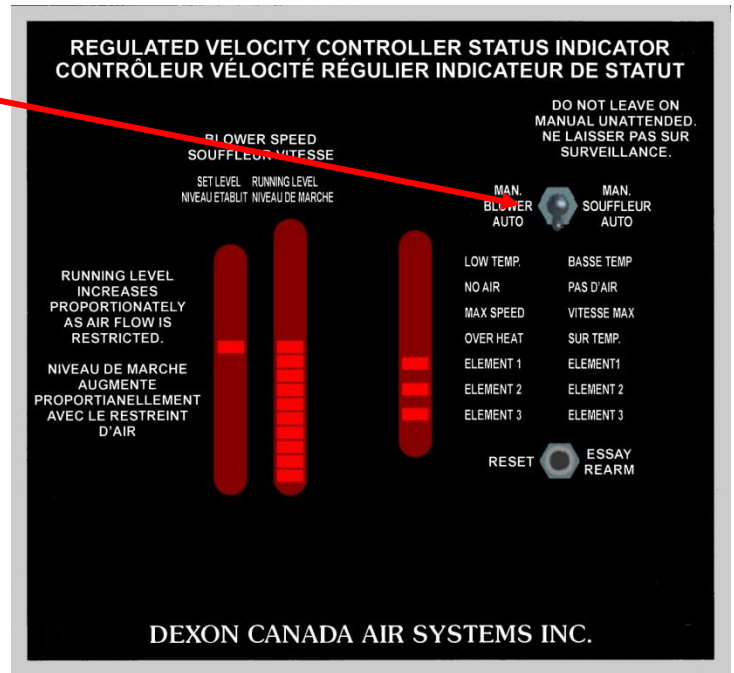

Figure 5: “Manual/Auto” Toggle Switch

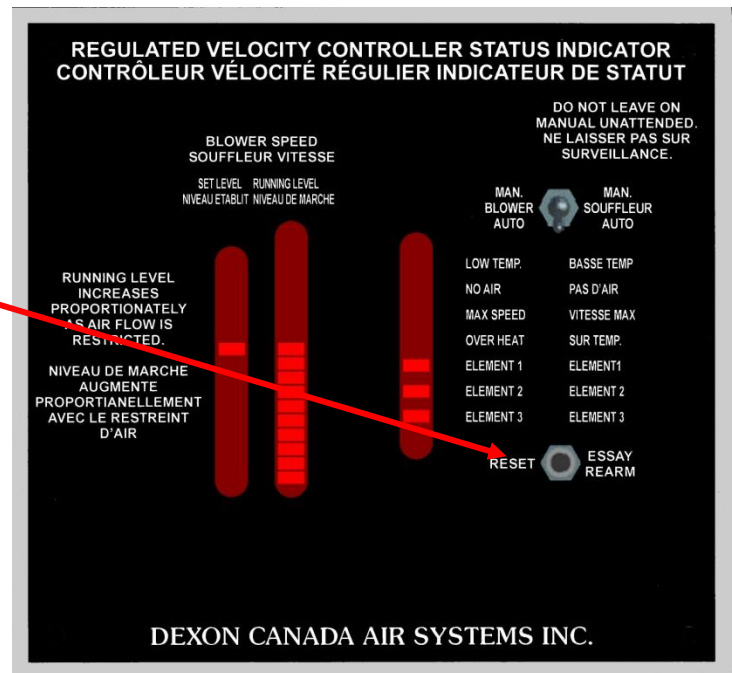

Figure 6: “Reset” Switch

CONTACT INFORMATION:

Email: techsupport@dexoncanada.com, Website: www.dexoncanada.com
Tech Support Phone: 403-930-1284, Admin Phone: 403-272-0562

7. WARRANTY

Limited Warranty

Dexon Canada Air Systems Inc. warrants its Blower Heater and Vent Fans to be free of defects in material and workmanship for a period of one (1) year from start up or eighteen (18) months from shipment, whichever comes first.

This warranty does not extend to abnormal or abusive wear and tear or improper installations and operations. All units and components of the unit must be installed according to Dexon's installation instructions provided with each unit. Responsibility for proper installation and operations must rest on the purchaser. Once properly installed all units must be operated as intended and maintained as outlined in owners and operators manuals supplied with each unit, and as per tags on each unit.

If the unit is shut down for any reason the unit must be completely sealed off to prevent any gases from entering the inside of the unit. This includes ducting/discharge, conduit and bolt holes, or any holes that would allow air to migrate into the unit. When removing the inside panels for repair or service, the discharge duct and any holes must still be covered in such a way as to prevent moisture from entering the body of the Blower Heater or Vent Fan.

Dexon's sole obligation under this warranty shall be to replace or repair defective parts or workmanship if upon evaluation it has been determined that they are defective and not a result of abnormal or abusive wear and tear or improper installations and operations.

Warranty services will only be extended to the original purchaser. In order to obtain warranty service the owner must ship the product prepaid to Dexon for evaluation. Dexon will ship the replaced or repaired product back prepaid if evaluation has determined that they are defective.

Dexon Canada Air Systems Inc.
5018 80th Ave. SE
Calgary, AB T2C 2X3
Phone: (403) 272-0562, Fax: (403) 235-0149
Email: dexoncan@dexoncanada.com, techsupport@dexoncanada.com

8. DRAWINGS

8.1 DIMENSION DRAWING

8.2 BOTTOM FOOTPRINT

8.3 INTERNAL WIRING

8.4 FIELD WIRING

8.5 OPTIONAL RVDHALM ALARM MODULE

This RVDH Alarm Module is equipped with three form C Relays with contacts rated at 2A, 250V for connecting to warning devices such as Automatic Dialing Equipment, Central Monitoring, Audible and /or Visual Alarms etc.. The alarm module is connected to the back of the status board with a 6 pin connector and secured with four 6-32 screws on a 1/2" sleeve. Please note the Alarm Module can be installed at any time. Contacts are provided for the following conditions:

Overheat = **O.H.** Low Temp. = **L.T.** No Air = **N.A.**

Please Note:

- All Relays and contacts are shown in the DE-ENERGIZED state.
- The "N.A." relay is energized when the blower heater control power is on.

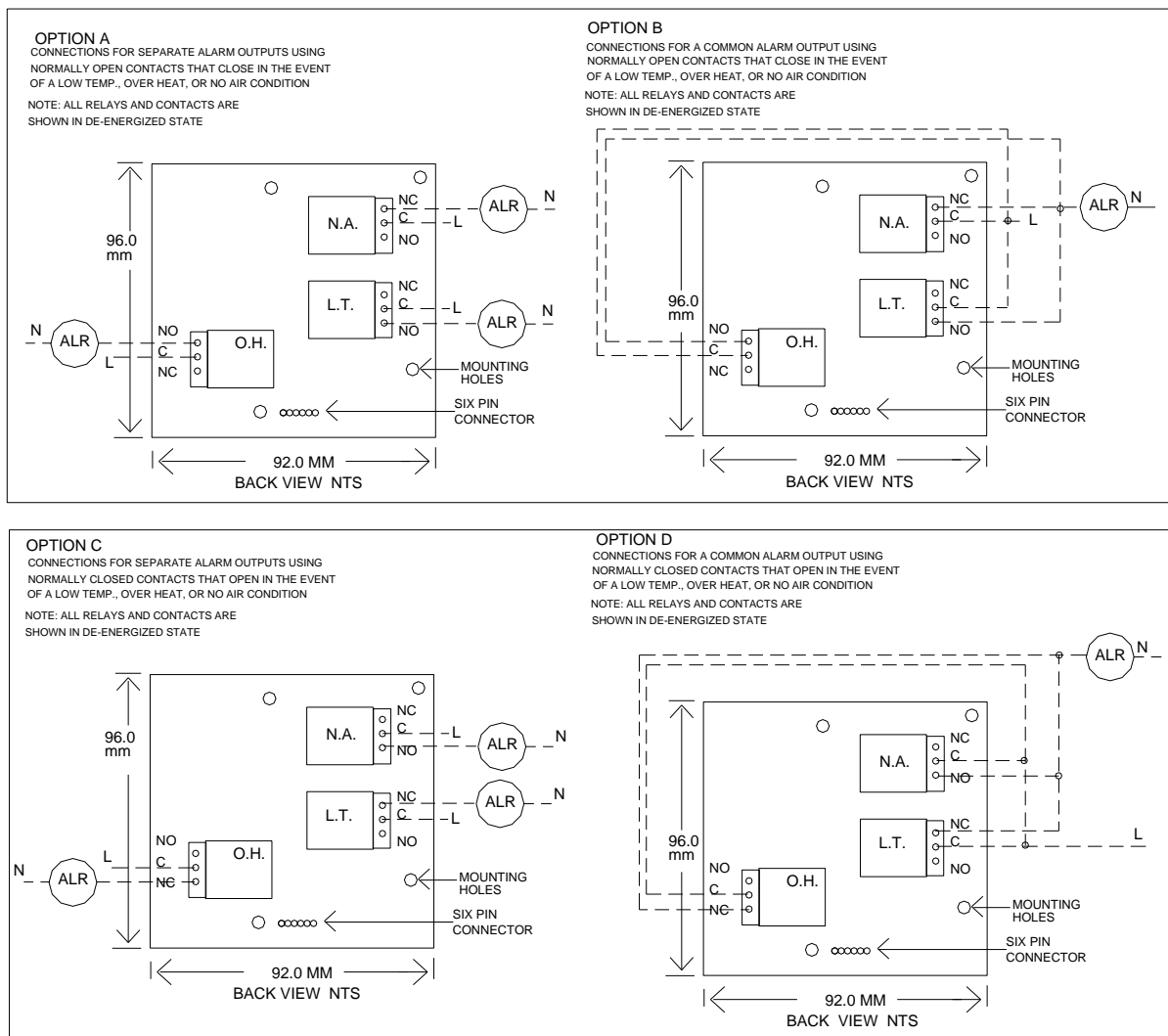

The alarm module must be removed in order to move the peg on back of status board when setting the fan speed as per installation instructions. When adjustments are complete replace the alarm module.